

# Fingerskaret træ/Alu vinduer

## 128, 157, 103 mm. karm, 3 lags glas

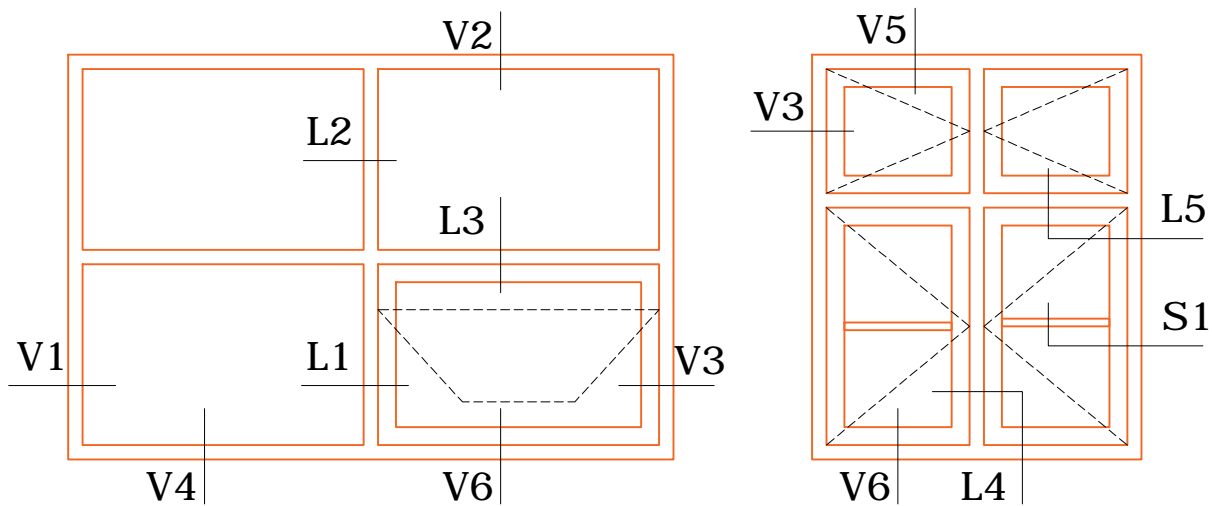

V2: Topkarm faste partier

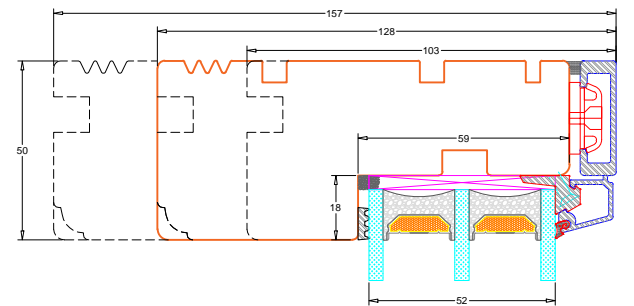

V4: Bundkarm faste partier

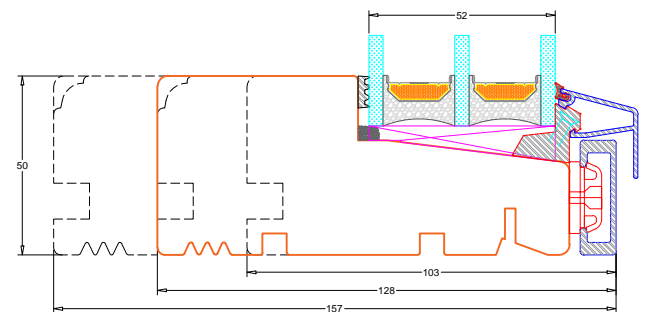

V1: Sidekarme faste partier

L1: Lodpost, fast/åbenbar lodret

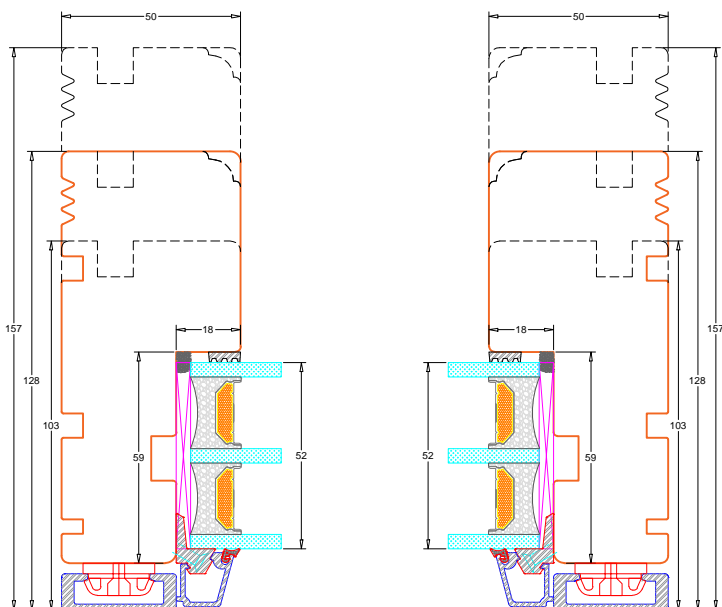

V5: Topkarm åbenbare eller faste partier med ramme

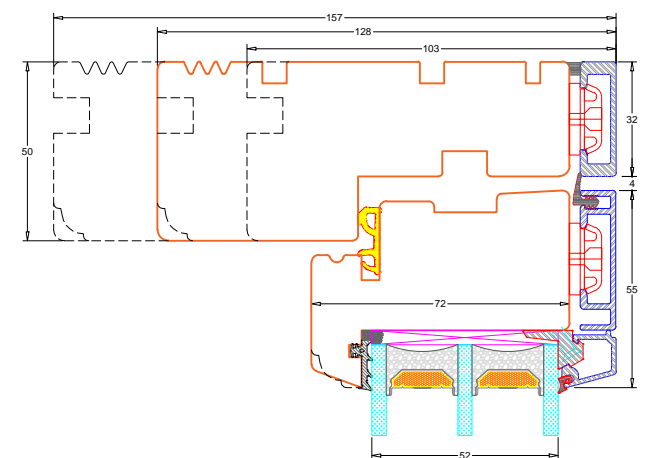

V3: Sidekarme åbenbare eller faste partier med ramme

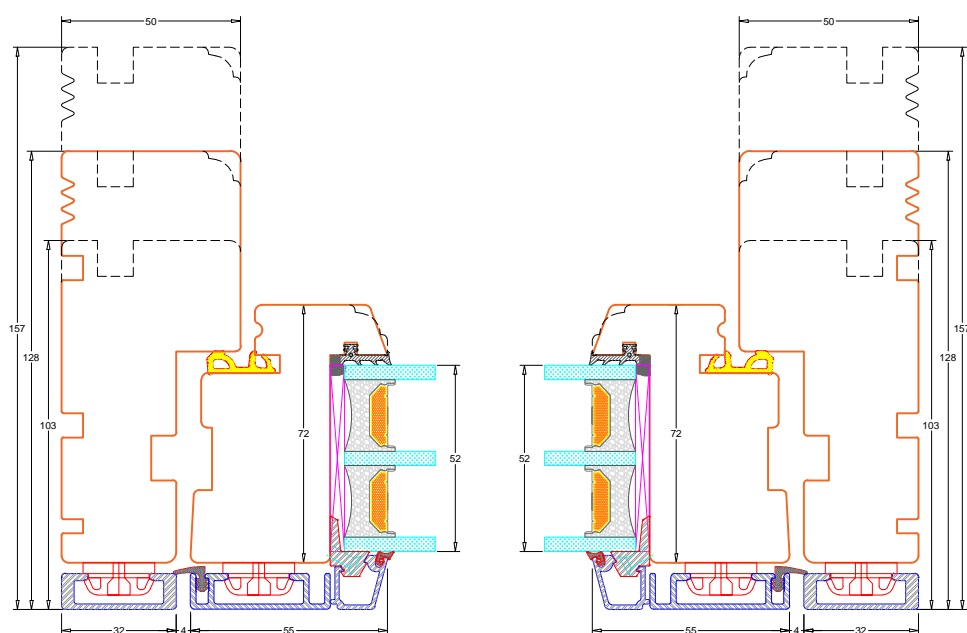

V6: Topkarm åbenbare eller faste partier med ramme

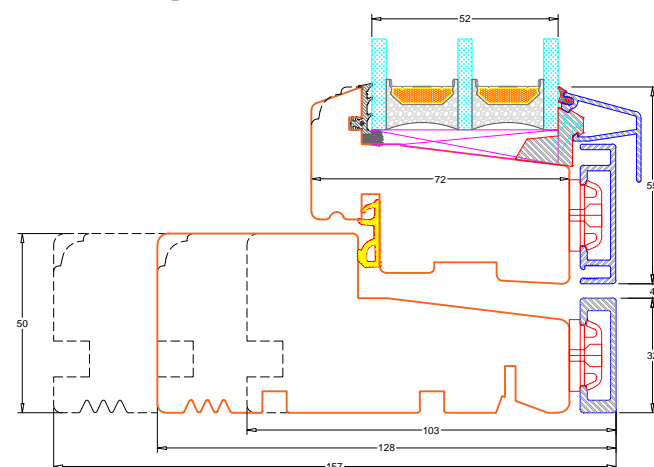

# Fingerskaret træ/Alu vinduer

## 128, 157, 103 mm. karm, 3 lags glas

### S1: Sprosemuligheder

24 mm. energisprosse  
Modern

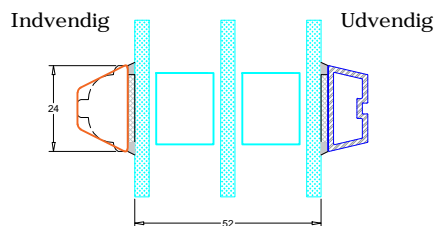

42 mm. energisprosse  
Modern

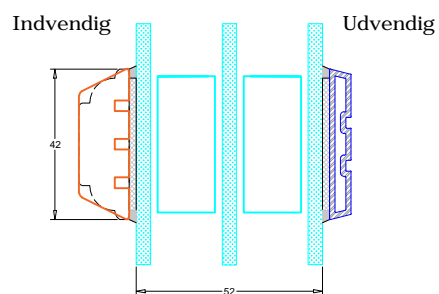

64 mm. gennemgående sprosse  
Modern

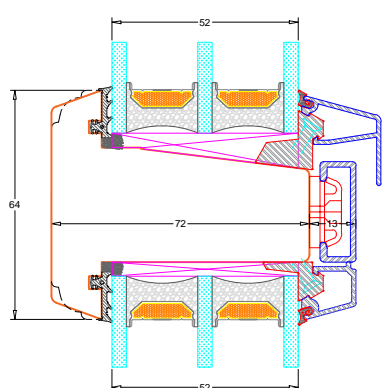

64 mm. gennemgående sprosse  
Modern

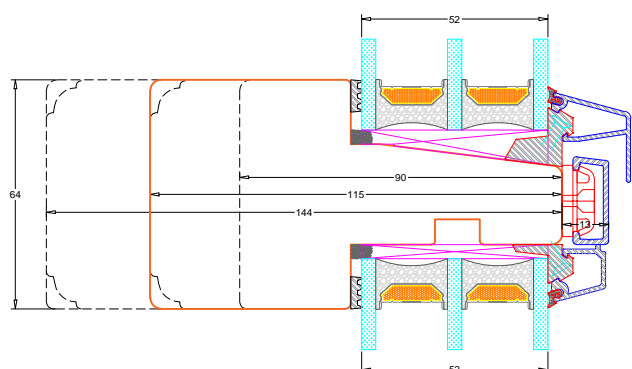

### L3: Lodpost, fast/åbenbar vandret

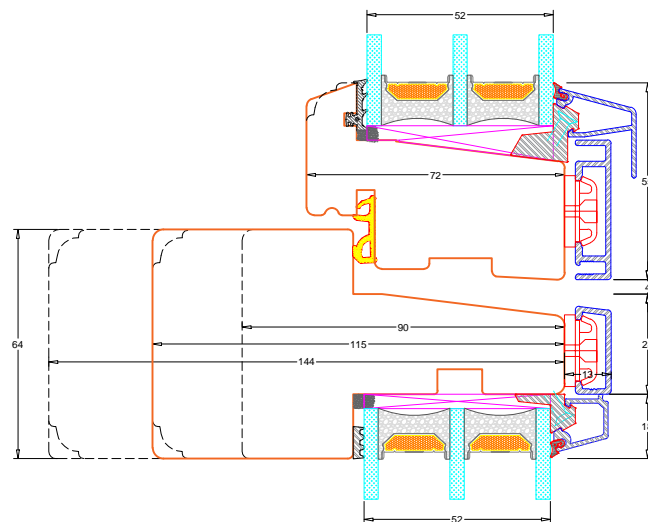

### L2: Lodpost, fast/fast lodret

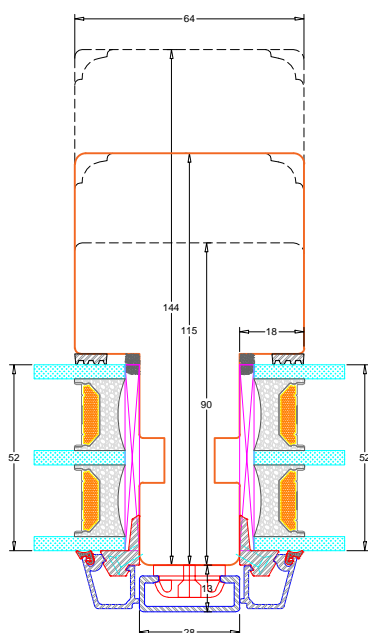

### L5: Lodpost, fast/åbenbar vandret

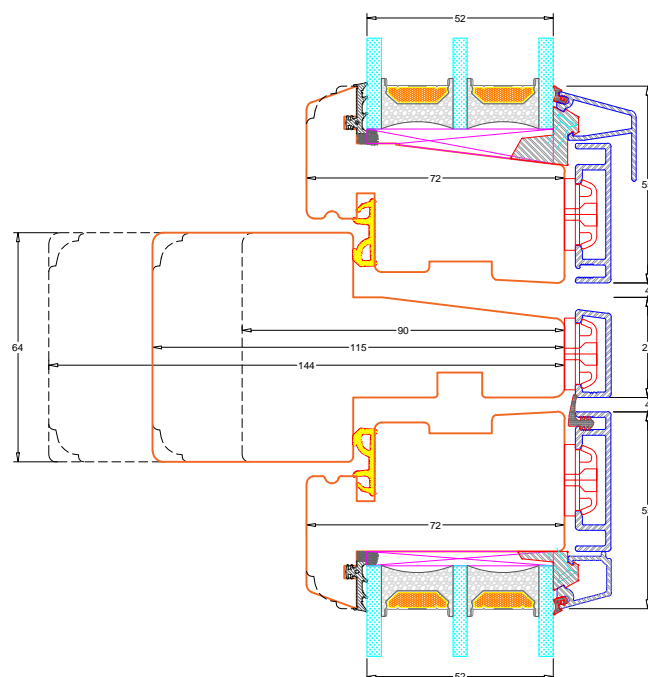

### L4: Lodpost, fast/åbenbar lodret

