

Fingerskaret træ døre og partier

115, 144, 90 mm. karm, 2 lags glas

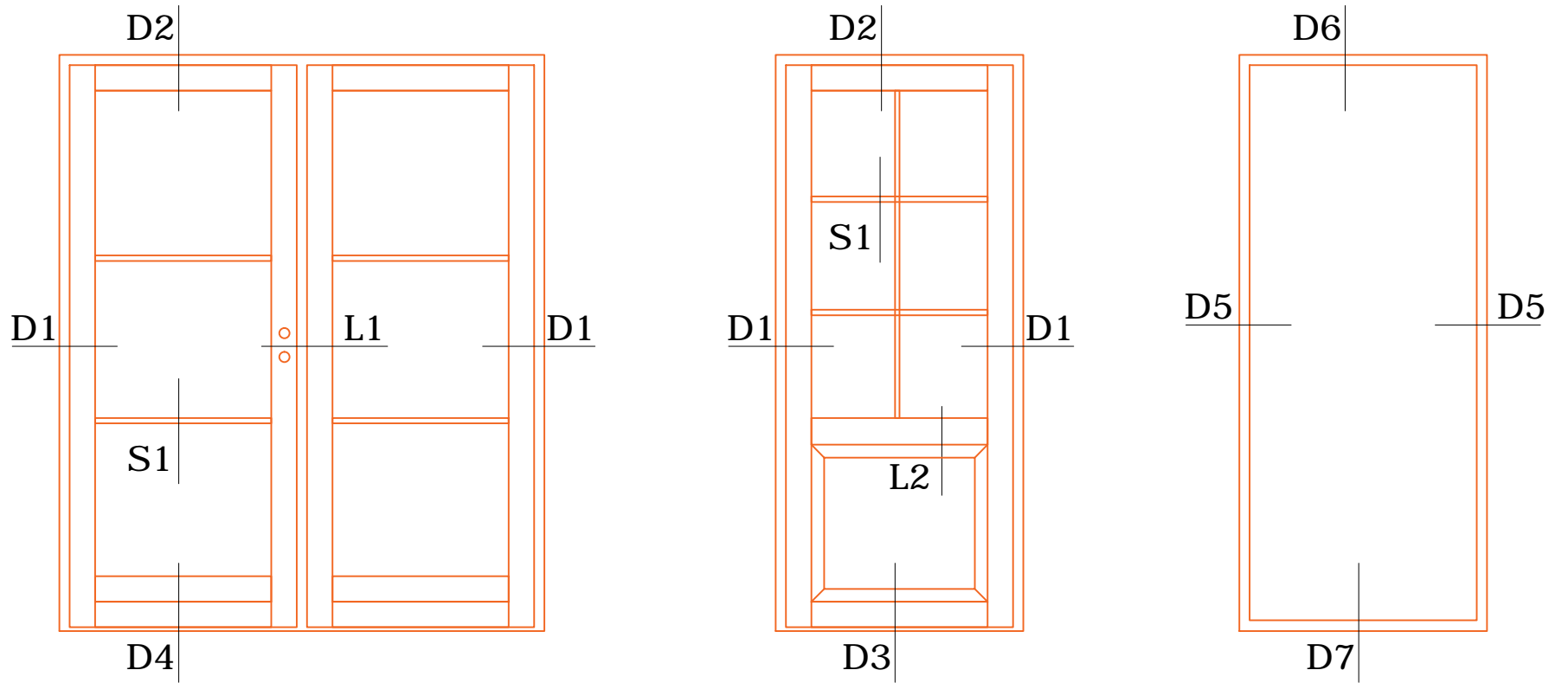

D1: Sidekarme døre, udadgående

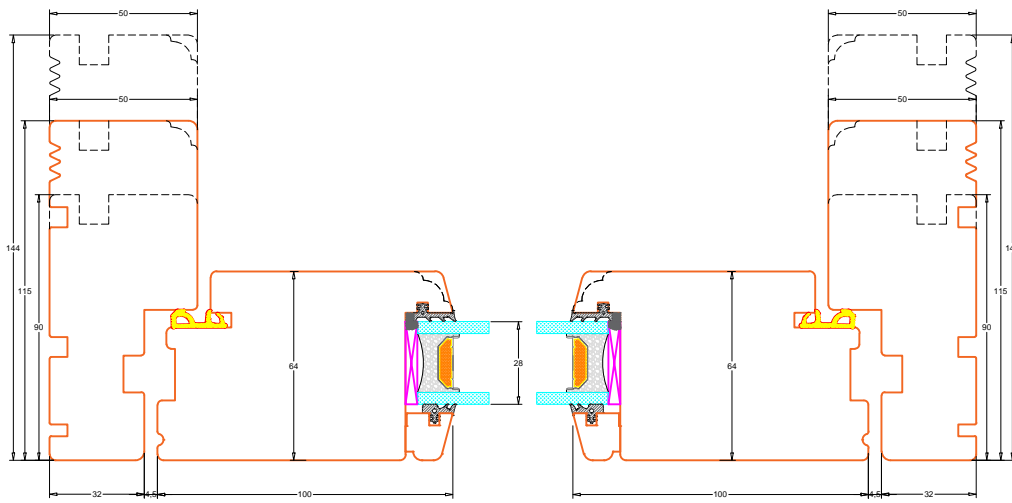

D6: Faste elementer, top karm

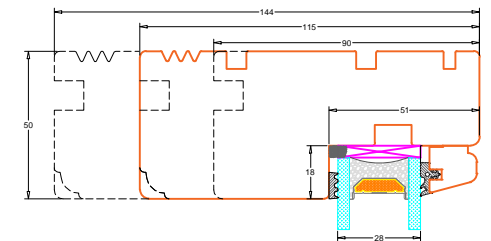

D1: Sidekarme døre, indadgående

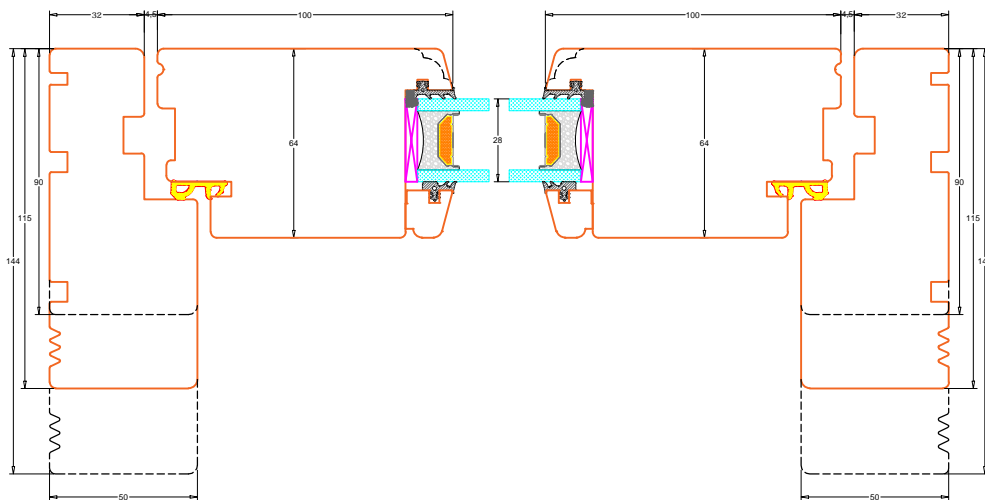

D5: Faste elementer, side karme

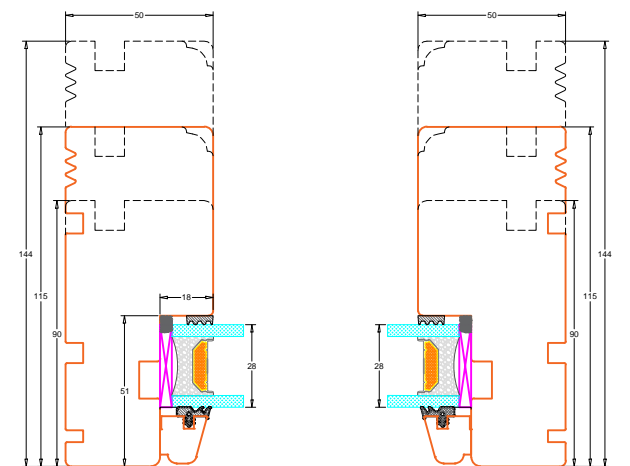

D2: Topkarme døre, udadgående

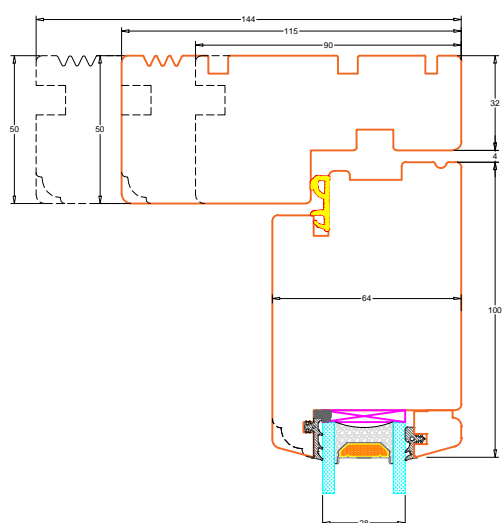

D2: Topkarme døre, indadgående

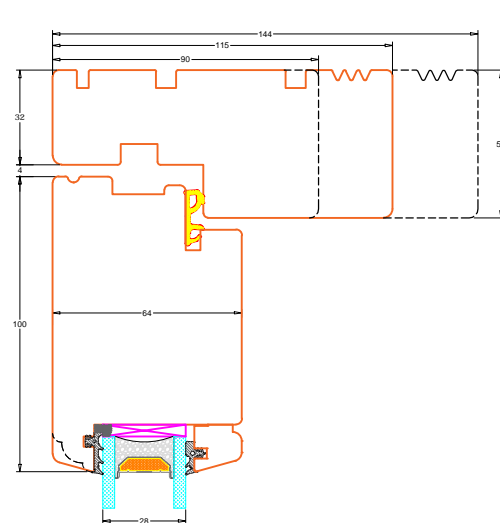

D7: Faste elementer, bund karm

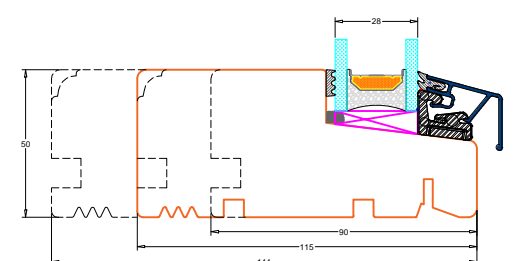

Fingerskaret træ døre og partier

115, 144, 90 mm. karm, 2 lags glas

D3: Dørtrin udadgående dør
(kan leveres med dobbelt spændestykke)

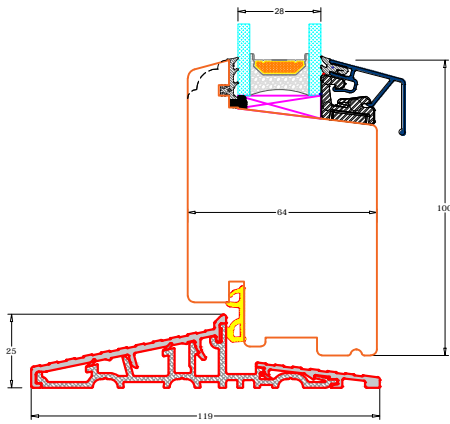

D3: Dørtrin indadgående dør
(kan leveres med dobbelt spændestykke)

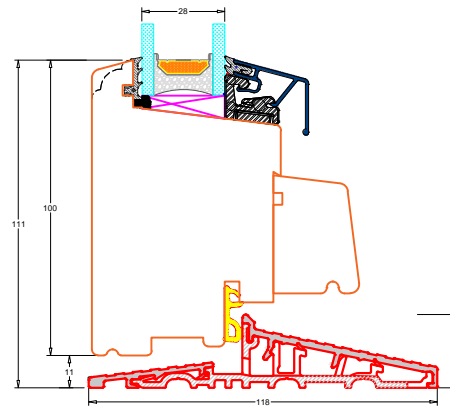

S1: Sprossmuligheder

24 mm. energisprosse
Modern

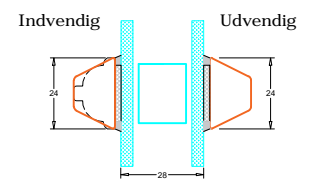

42 mm. energisprosse
Modern

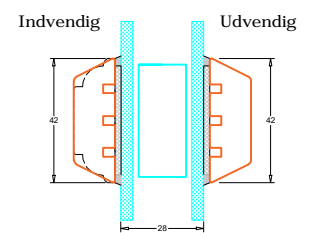

D4: Dørtrin udadgående dør
(kan leveres med enkelt spændestykke)

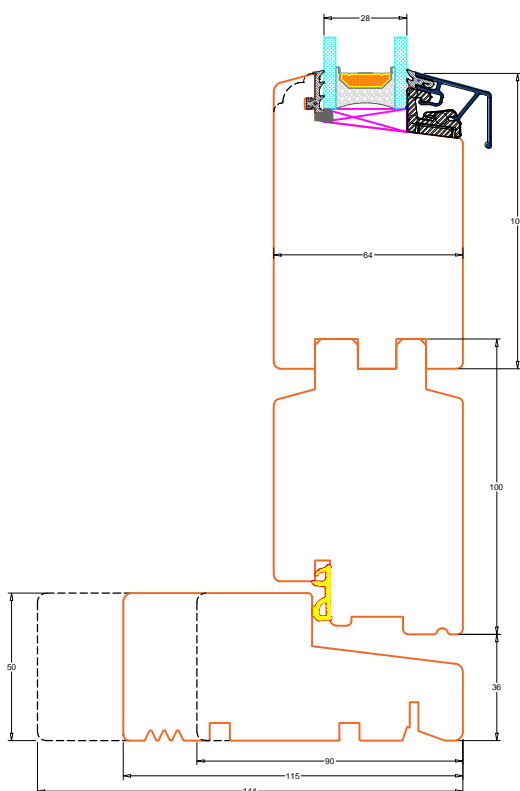

D4: Dørtrin indadgående dør
(kan leveres med enkelt spændestykke)

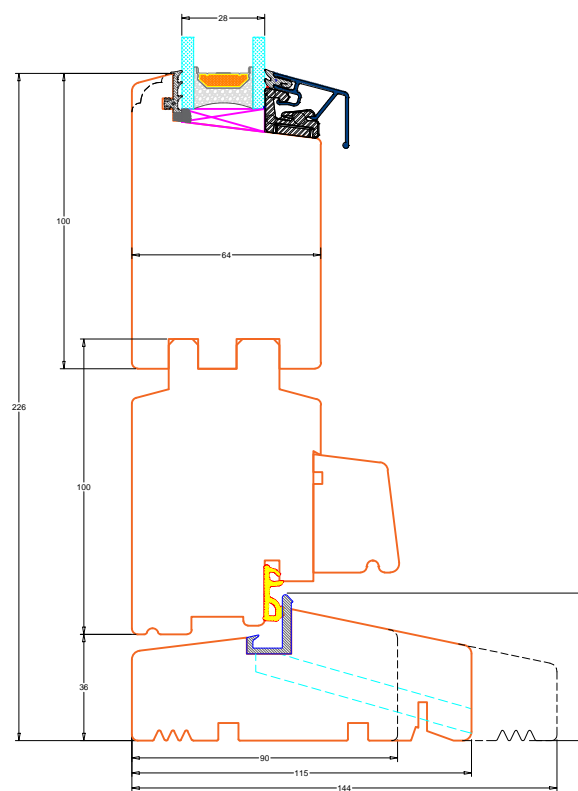

64 mm. gennemgående sprosse
Modern

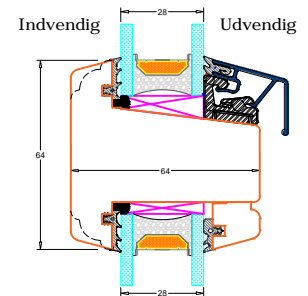

100 mm. gennemgående sprosse
Modern

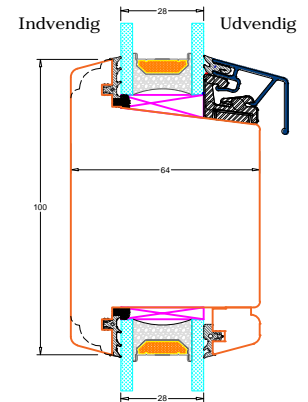

L2: Lodpost vandret

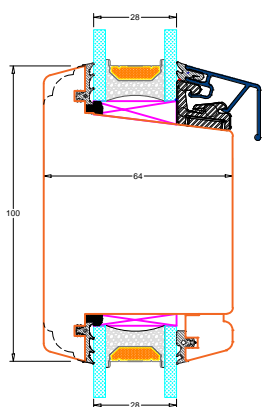

L1: Lodpost lodret
udadgående dør

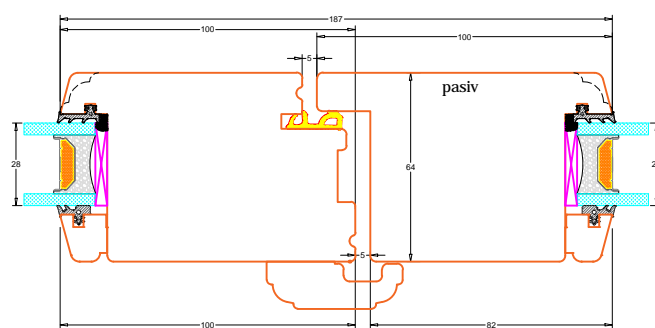

L1: Lodpost lodret
indadgående dør

